



# SARIGÜLLER Limited

SARIGÜLLER MÜH. İNŞ. ve YAPI ELM. SAN. TİC. LTD. ŞTİ.  
EĞİTİM MAH. KASAP İSMAIL SOK. AVRASYA İŞ M. KAT:1 D:16 HASANPAŞA/İSTANBUL  
TEL: 0 216 337 43 10 - 0 216 337 43 11 FAX: 0 216 337 43 09

KONU/SUBJECT:

SAYFA NO:  
PAGE NO:

28

SİFONLU YER SÜZGEÇİ  
FLOOR DRAIN  
WITH SIPHON

SCALE:  
ÖLÇEK:

1/5

RESİM NO:  
DWG. NO:

S219220.DWG

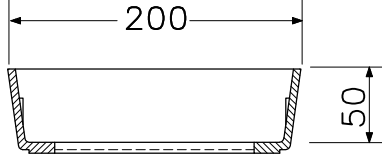

YÜKSELTME PARÇASI  
ELEVATOR

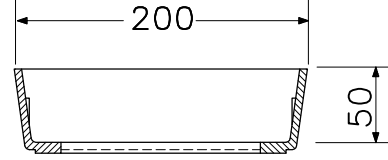

YÜKSELTME PARÇASI  
ELEVATOR

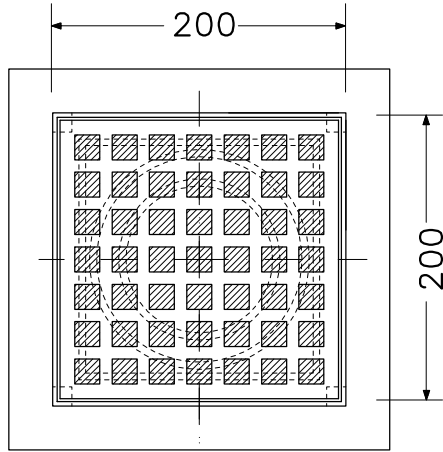

PLAN

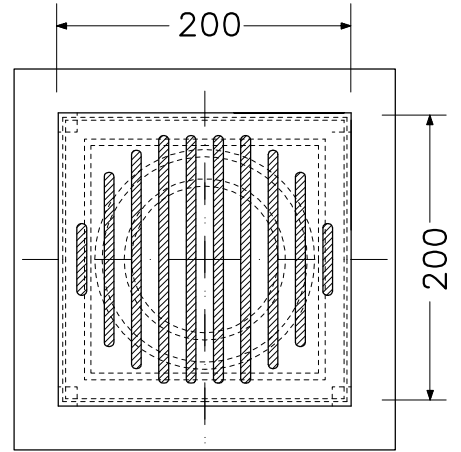

PLAN

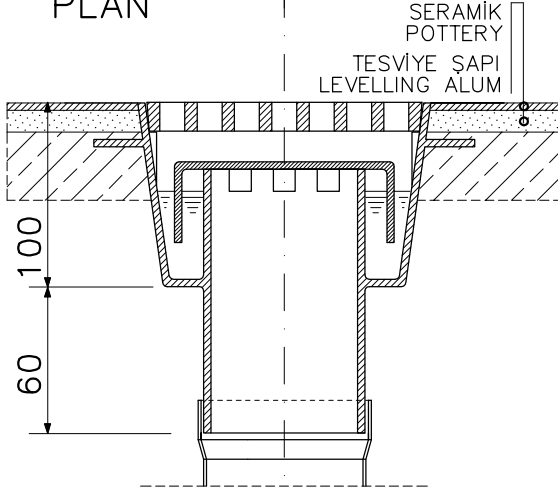
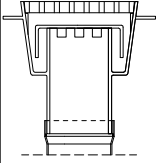

KESİT  
SECTION

Ø100  
Ø70

S219- 70 (200x200)  
S220-100 (200x200)

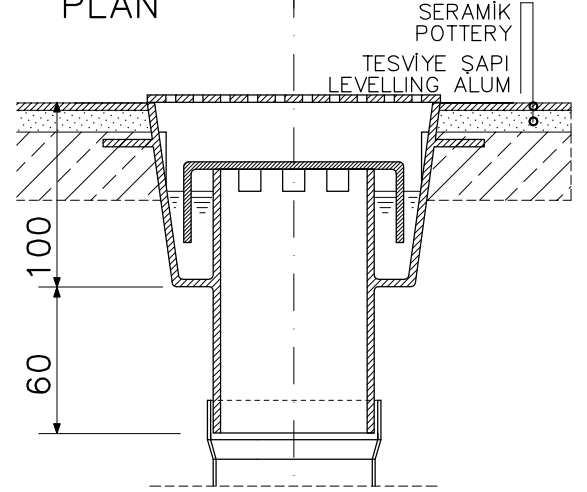

KESİT  
SECTION

Ø100  
Ø70

S219- 70 (200x200)  
S220-100 (200x200)

KOD NO: CODE NO:	ÇAP DİAMETER	AĞIRLIK WEIGHT kg.	KESİT KALINLIĞI WALL THICKNESS mm.	MALZEME/ MATERIALS	
				ALT GÖVDE BOTTOM PART	ÜST İZGARA UPPER GRATING
S219- 70	Ø70	13	5	PİK DÖKÜM CASTING	PİK, ALÜMİNYUM, PİRİNÇ, PİRİNÇ+KROMAJ CAST-IRON, ALUMINUM, BRASS, BRASS+CHROMIUM PLATING
S220-100	Ø100	14			