



# SARIGÜLLER Limited

SARIGÜLLER MÜH. İNŞ. ve YAPI ELM. SAN. TİC. LTD. ŞTİ.  
EĞİTİM MAH. KASAP İSMAIL SOK. AVRASYA İŞ M. KAT:1 D:16 HASANPAŞA/İSTANBUL  
TEL: 0 216 337 43 10 - 0 216 337 43 11 FAX: 0 216 337 43 09

KONU/SUBJECT:

ÇATI SÜZGEÇİ  
ROOF GULLY

SAYFA NO:  
PAGE NO:

3

SCALE:  
ÖLÇEK:

1/5

RESİM NO:  
DWG. NO:

S101105. DWG

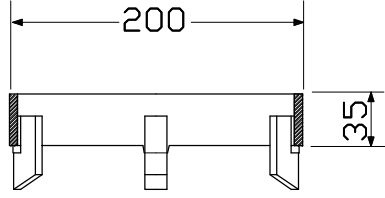
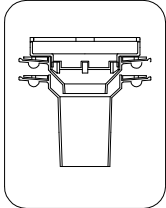
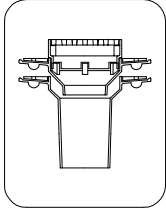
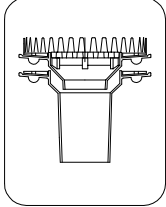
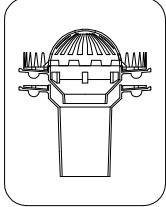
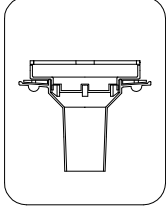
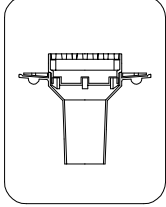
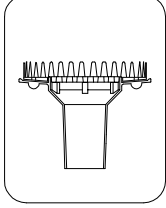
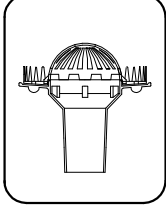

YÜKSELTME HALKASI  
CLAMPING RING

PLAN

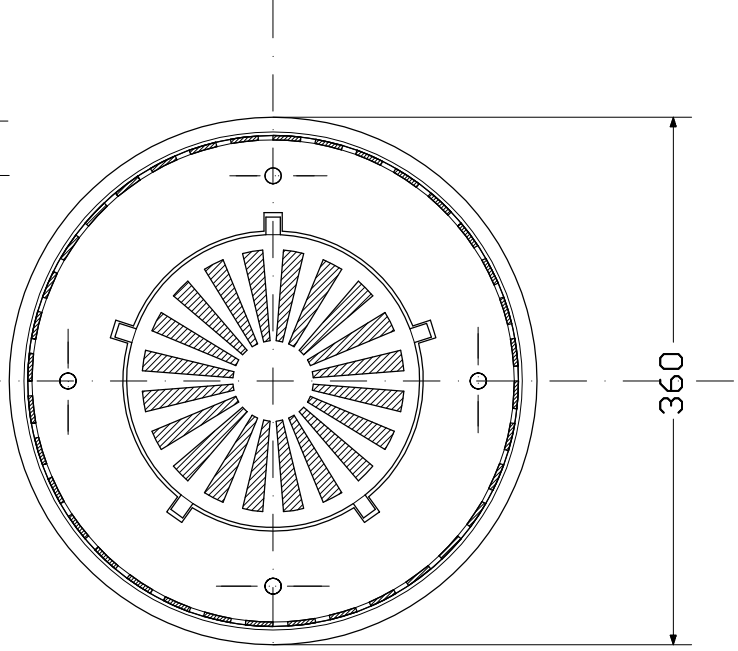

KÜRESEL İZGARA  
SPHERICAL GRID

ÇAKIL  
GRAVEL

SU YALITIMI  
WATER PROOFING

EĞİM BETONU  
INCLINED CONCRETE

B.A. DÖŞEME  
REINFORCED CONCRETE FLOORING

SIVA  
PLASTER

KESİT/SECTION

KOD NO: CODE NO:	ÇAP DIAMETER	AĞIRLIK WEIGHT kg.	KESİT KALINLIĞI WALL THICKNESS mm.	SERVİS ALANI SERVICE AREA m <sup>2</sup>	MALZEME/ MATERIALS	
					ALT GÖVDE BOTTOM PART	ÜST İZGARA UPPER GRATING
S101-70	Ø70	17	5	50	PIK DÖKÜM CASTING	PIK DÖKÜM CASTING
S102-100	Ø100	18		150		
S103-125	Ø125	20		250		
S104-150	Ø150	21		400		
S105-200	Ø200	24		500		