



SARIGÜLLER Limited

SARIGÜLLER MÜH. İNŞ. ve YAPI ELM. SAN. TİC. LTD. ŞTİ.
EĞİTİM MAH. KASAP İSMAIL SOK. AVRASYA İŞ M. KAT:1 D:16 HASANPAŞA/İSTANBUL
TEL: 0 216 337 43 10 - 0 216 337 43 11 FAX: 0 216 337 43 09

KONU/SUBJECT:

ÇATI SÜZGEÇİ
ROOF GULLY

SAYFA NO:
PAGE NO:

4

SCALE:
ÖLÇEK:

1/5

RESİM NO:
DWG. NO:

S106110. DWG

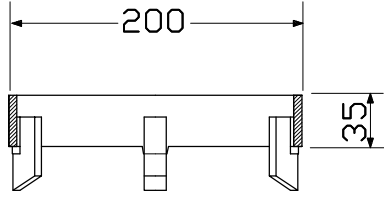
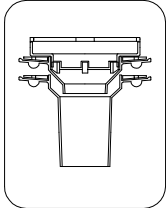
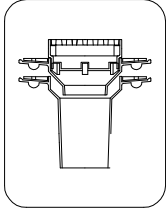
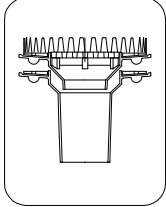
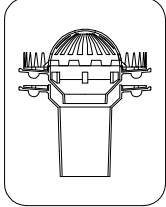
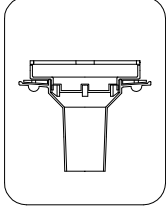
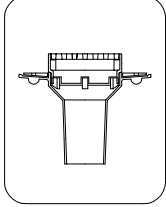
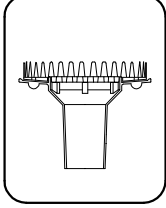
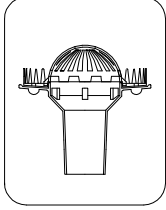

YÜKSELTME HALKASI
CLAMPING RING

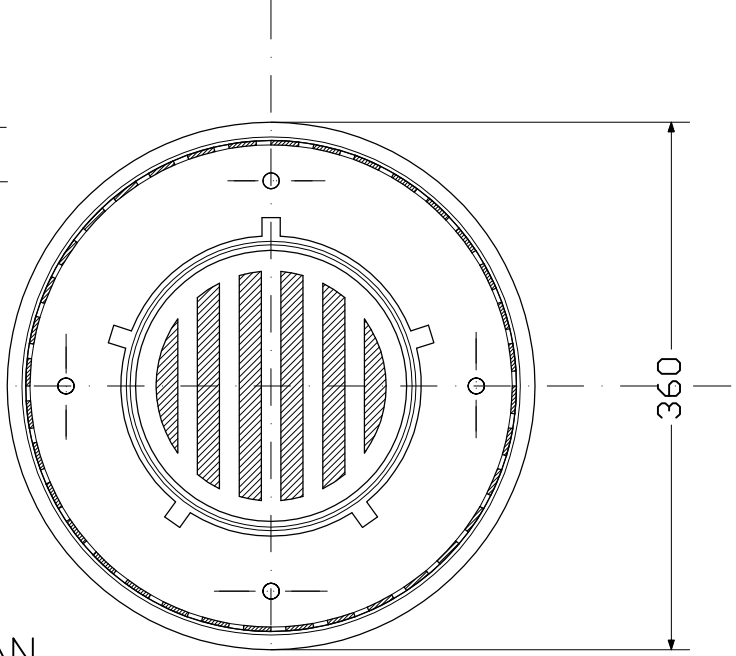

PLAN

ÇAKIL
GRAVEL

SU YALITIMI
WATER PROOFING

EĞİM BETONU
INCLINED CONCRETE

B.A. DÖŞEME
REINFORCED CONCRETE FLOORING

SIVA
PLASTER

DAİRESEL DÜZ IZGARA
CIRCULAR FLAT GRID

KESİT/SECTION

250

KOD NO: CODE NO:	ÇAP DIAMETER	AĞIRLIK WEIGHT kg.	KESİT KALINLIĞI WALL THICKNESS mm.	SERVİS ALANI SERVICE AREA m ²	MALZEME/ MATERIALS	
					ALT GÖVDE BOTTOM PART	ÜST IZGARA UPPER GRATING
S106-70	Ø70	17	5	50	PIK DÖKÜM CASTING	PIK DÖKÜM CASTING
S107-100	Ø100	18		150		
S108-125	Ø125	20		250		
S109-150	Ø150	21		400		
S110-200	Ø200	24		500		