



SARIGÜLLER Limited

SARIGÜLLER MÜH. İNŞ. ve YAPI ELM. SAN. TİC. LTD. ŞTİ.
EĞİTİM MAH. KASAP İSMAIL SOK. AVRASYA İŞ M. KAT:1 D:16 HASANPAŞA/İSTANBUL
TEL: 0 216 337 43 10 - 0 216 337 43 11 FAX: 0 216 337 43 09

KONU/SUBJECT:

ISI YALITIMLI
ÇATI SÜZGEÇİ

ROOF GULLY WITH
THERMAL INSULATION

SAYFA NO:
PAGE NO:

7

SCALE:
ÖLÇEK:

1/5

RESİM NO:
DWG. NO:

S121124. DWG

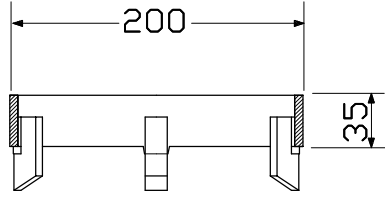
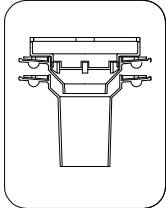
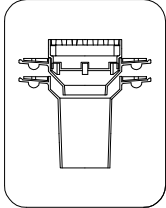
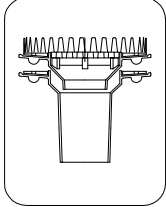
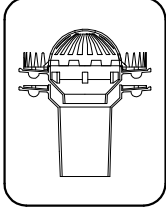
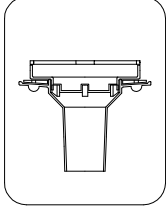
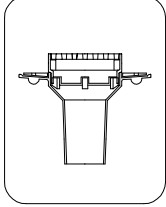
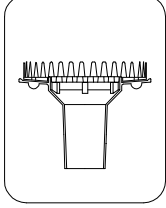
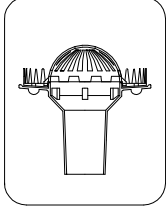

YÜKSELTME HALKASI
CLAMPING RING

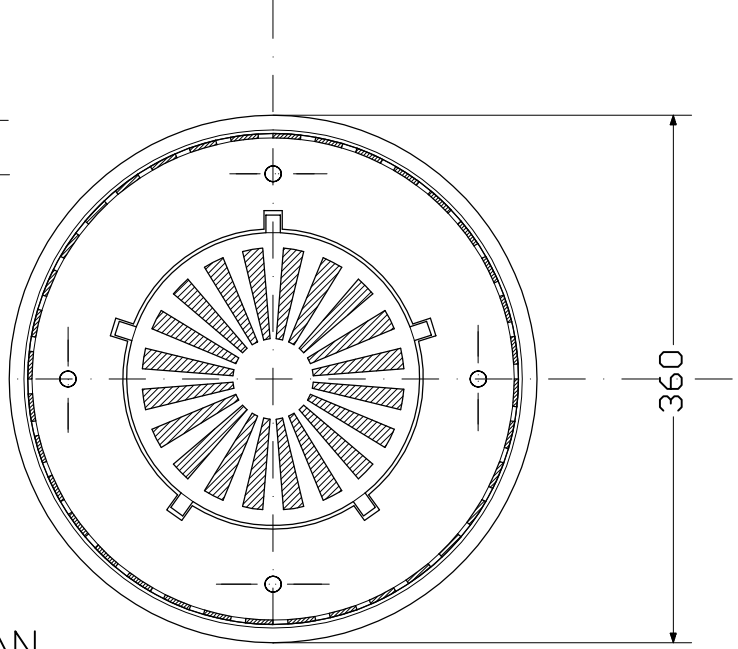

PLAN

KÜRESEL İZGARA
SPHERICAL GRID

ÇAKIL
GRAVEL
SU YALITIMI
WATER PROOFING
ISI YALITIMI
THERMAL INSULATION
SU YALITIMI
WATER PROOFING
EĞİM BETONU
INCLINED CONCRETE
B.A. DÖŞEME
REINFORCED CONCRETE FLOORING
SIVA
PLASTER

KESİT/SECTION

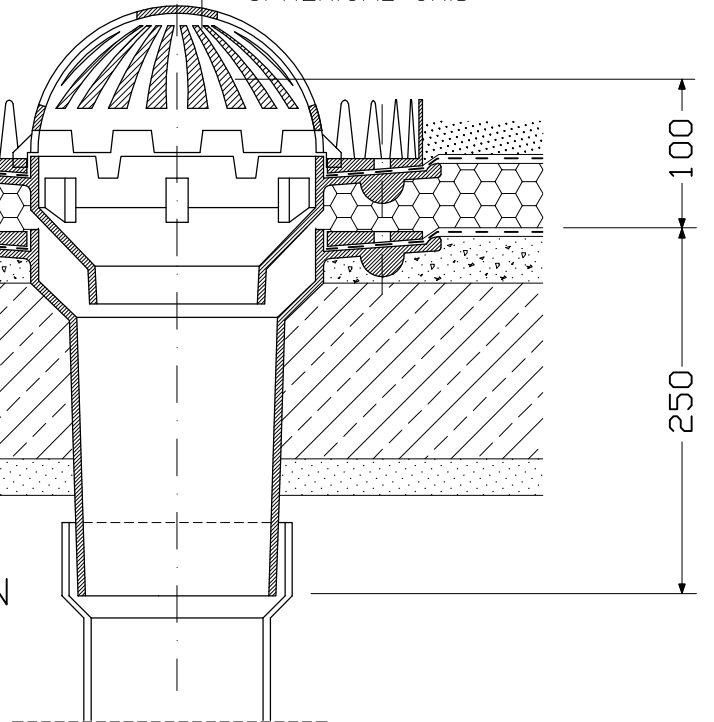

KOD NO: CODE NO:	ÇAP DIAMETER	AĞIRLIK WEIGHT kg.	KESİT KALINLIĞI WALL THICKNESS mm.	SERVİS ALANI SERVICE AREA m ²	MALZEME/ MATERIALS	
					ALT GÖVDE BOTTOM PART	ÜST İZGARA UPPER GRATING
S121-100	Ø100	26	5	150	PIK DÖKÜM CASTING	PIK DÖKÜM CASTING
S122-125	Ø125	29		250		
S123-150	Ø150	30		400		
S124-200	Ø200	34		500		