



SARIGÜLLER Limited

SARIGÜLLER MÜH. İNŞ. ve YAPI ELM. SAN. TİC. LTD. ŞTİ.
EĞİTİM MAH. KASAP İSMAIL SOK. AVRASYA İŞ M. KAT:1 D:16 HASANPAŞA/İSTANBUL
TEL: 0 216 337 43 10 - 0 216 337 43 11 FAX: 0 216 337 43 09

KONU/SUBJECT:

ISI YALITIMLI
ÇATI SÜZGEÇİ
ROOF GULLY WITH
THERMAL INSULATION

SAYFA NO:
PAGE NO:

8

SCALE:
ÖLÇEK:

1/5

RESİM NO:
DWG. NO:

S125128. DWG

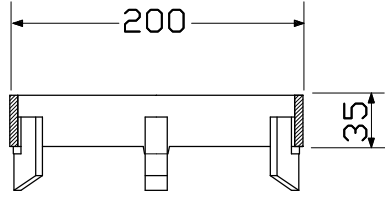
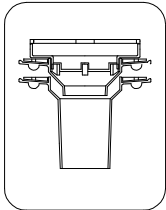
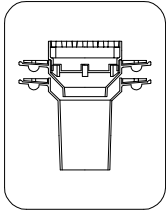
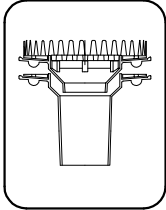
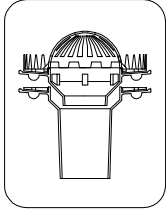
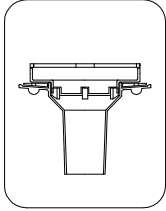
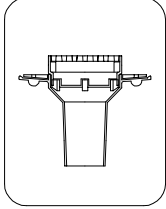
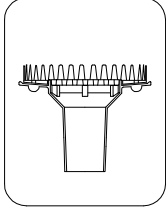
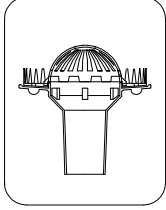

YÜKSELTME HALKASI
CLAMPING RING

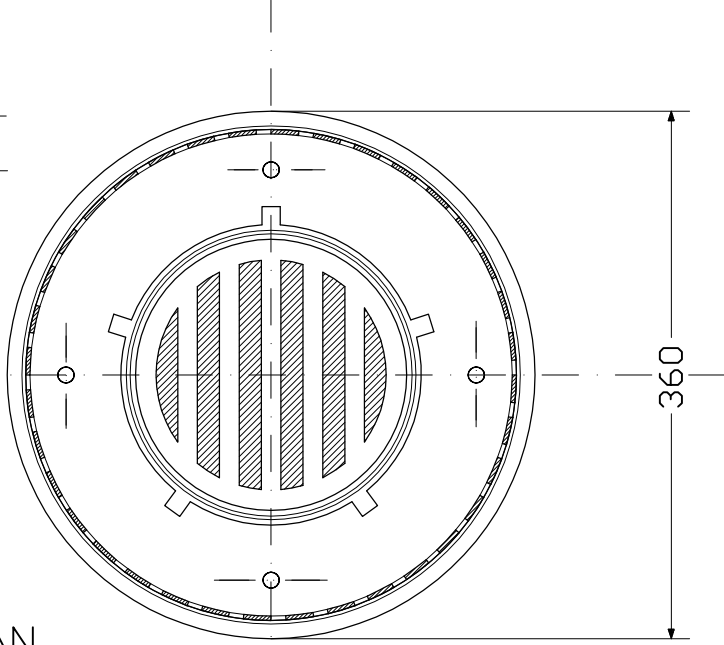

PLAN

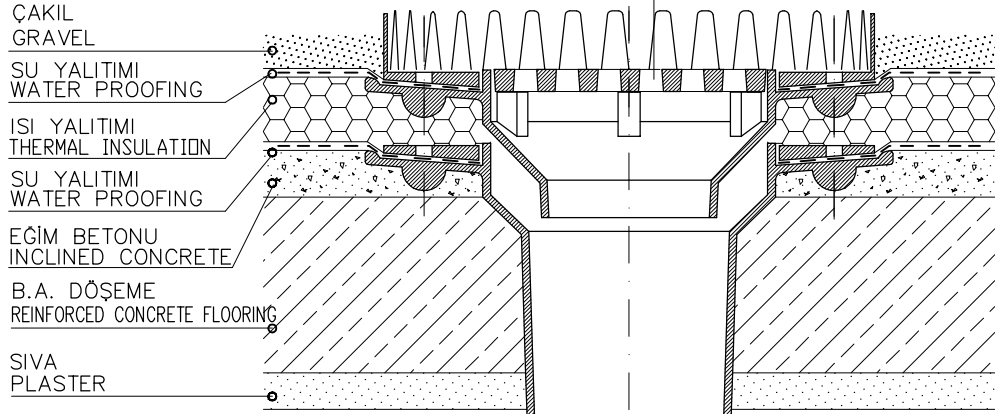

KESİT/SECTION

DAİRESEL DÜZ IZGARA
FLAT SQUARE GRID

ÇAKIL
GRAVEL

SU YALITIMI
WATER PROOFING

ISI YALITIMI
THERMAL INSULATION

SU YALITIMI
WATER PROOFING

EĞİM BETONU
INCLINED CONCRETE

B.A. DÖŞEME
REINFORCED CONCRETE FLOORING

SIVA
PLASTER

KOD NO:
CODE NO:

ÇAP
DIAMETER

AĞIRLIK
WEIGHT
kg.

KESİT KALINLIĞI
WALL THICKNESS
mm.

SERVİS ALANI
SERVICE AREA
m²

MALZEME/ MATERIALS

ALT GÖVDE
BOTTOM PART

ÜST IZGARA
UPPER GRATING

S125-100

Ø100

26

5

150

PIK DÖKÜM
CASTING

PIK DÖKÜM
CASTING

S126-125

Ø125

28

250

S127-150

Ø150

30

400

S128-200

Ø200

34

500