



SARIGÜLLER Limited

SARIGÜLLER MÜH. İNŞ. ve YAPI ELM. SAN. TİC. LTD. ŞTİ.
EĞİTİM MAH. KASAP İSMAIL SOK. AVRASYA İŞ M. KAT:1 D:16 HASANPAŞA/İSTANBUL
TEL: 0 216 337 43 10 - 0 216 337 43 11 FAX: 0 216 337 43 09

KONU/SUBJECT:

KÖPRÜ GAYGUYLARI
BRIDGE DRAIN

SAYFA NO:
PAGE NO:

82

SCALE:
ÖLÇEK:

1/5

RESİM NO:
DWG. NO:

S804806.DWG

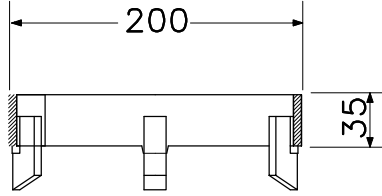
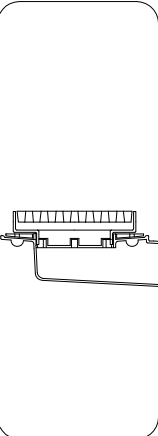
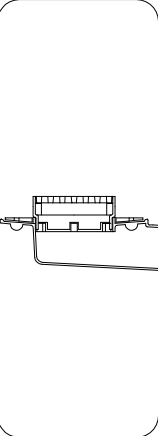
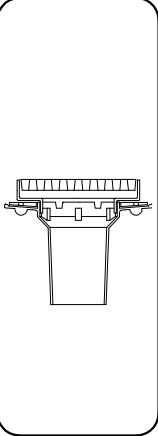
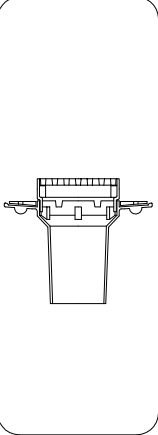

YÜKSELTME HALKASI
CLAMPING RING

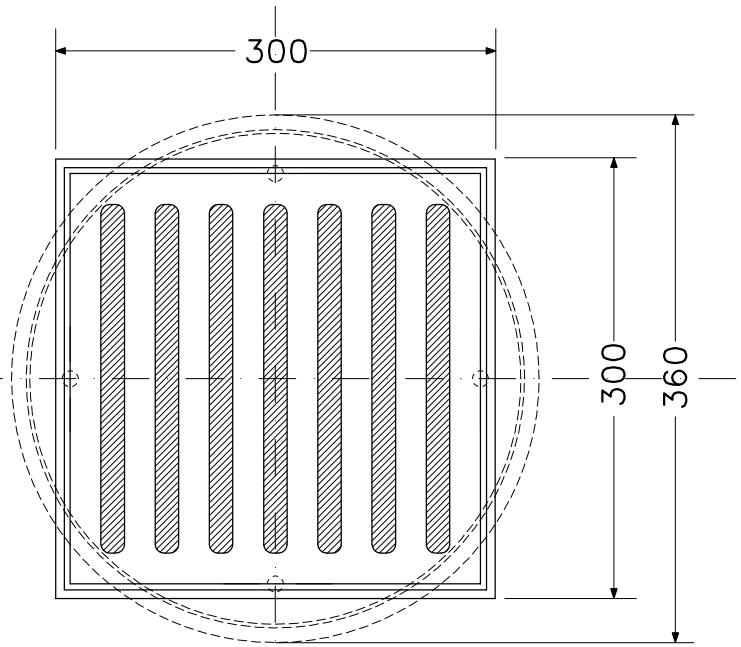

PLAN

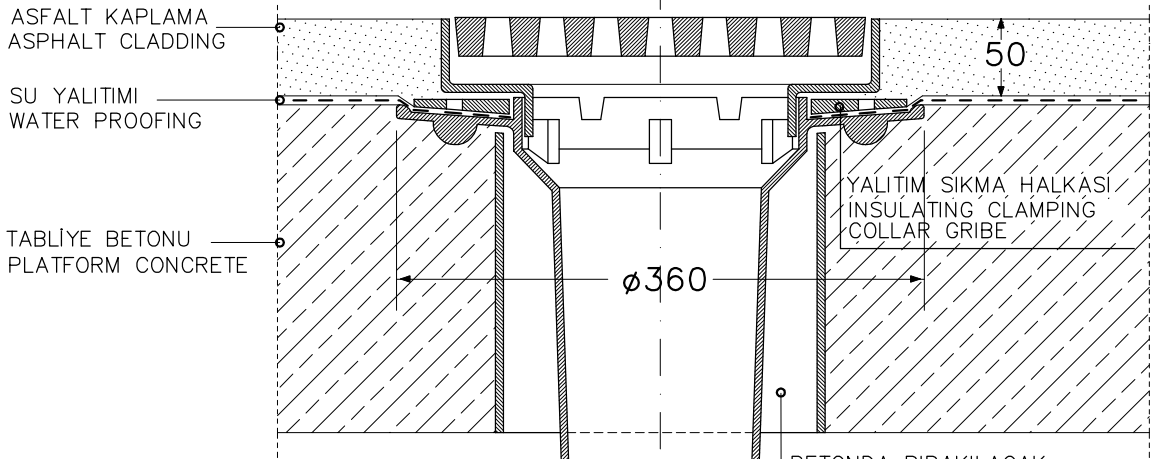

ASFALT KAPLAMA
ASPHALT CLADDING

SU YALITIMI
WATER PROOFING

TABLIYE BETONU
PLATFORM CONCRETE

YALITIM SIKMA HALKASI
INSULATING CLAMPING
COLLAR GRIBE

Ø360

BETONDA BIRAKILACAK
Ø230 LUK DELİK
Ø230 HOLE IN CONCRETE

KESİT/SECTION

KOD NO: CODE NO:	ÇAP DIAMETER	AĞIRLIK WEIGHT kg.	KESİT KALINLIĞI WALL THICKNESS mm.	SERVİS ALANI SERVICE AREA m ²	MALZEME/ MATERIALS	
					ALT GÖVDE BOTTOM PART	ÜST İZGARA UPPER GRATING
S804-125	Ø125	33	5	250	PIK DÖKÜM CASTING	PIK DÖKÜM CASTING
S805-150	Ø150	35		400		
S806-200	Ø200	38		500		