



SARIGÜLLER Limited

SARIGÜLLER MÜH. İNŞ. ve YAPI ELM. SAN. TİC. LTD. ŞTİ.
EĞİTİM MAH. KASAP İSMAIL SOK. AVRASYA İŞ M. KAT:1 D:16 HASANPAŞA/İSTANBUL
TEL: 0 216 337 43 10 - 0 216 337 43 11 FAX: 0 216 337 43 09

KONU/SUBJECT:

KÖPRÜ GAYGUYLARI
BRIDGE DRAIN

SAYFA NO:
PAGE NO:

83

SCALE:
ÖLÇEK:

1/5

RESİM NO:
DWG. NO:

S807.DWG

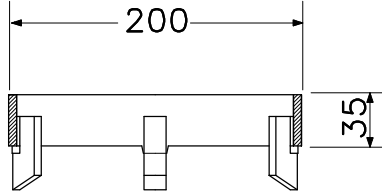
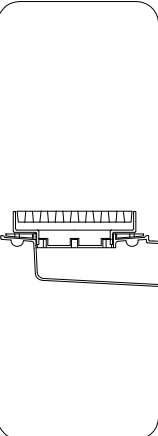
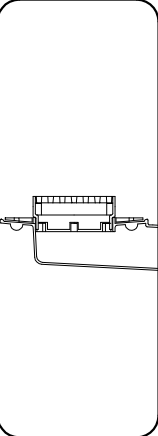
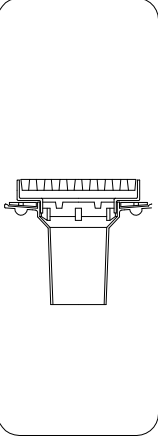
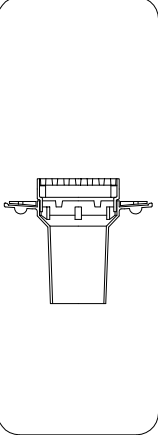

YÜKSELTME HALKASI
CLAMPING RING

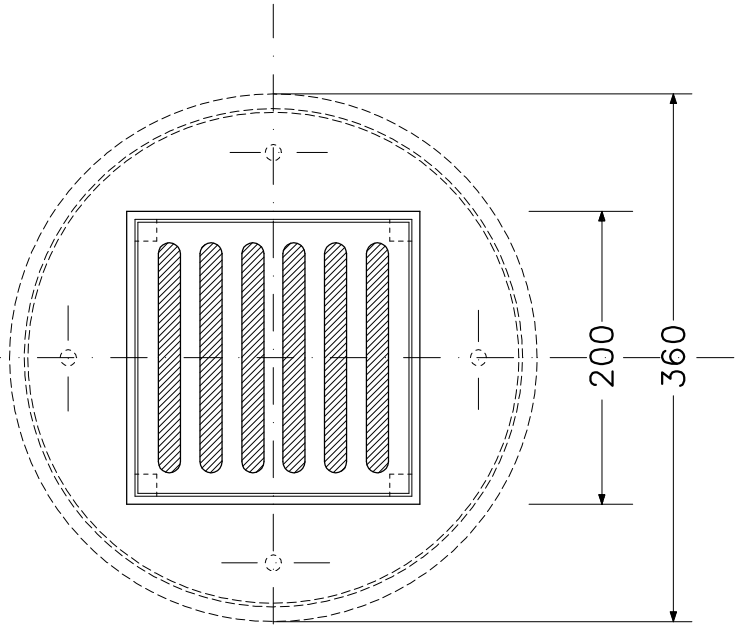

PLAN

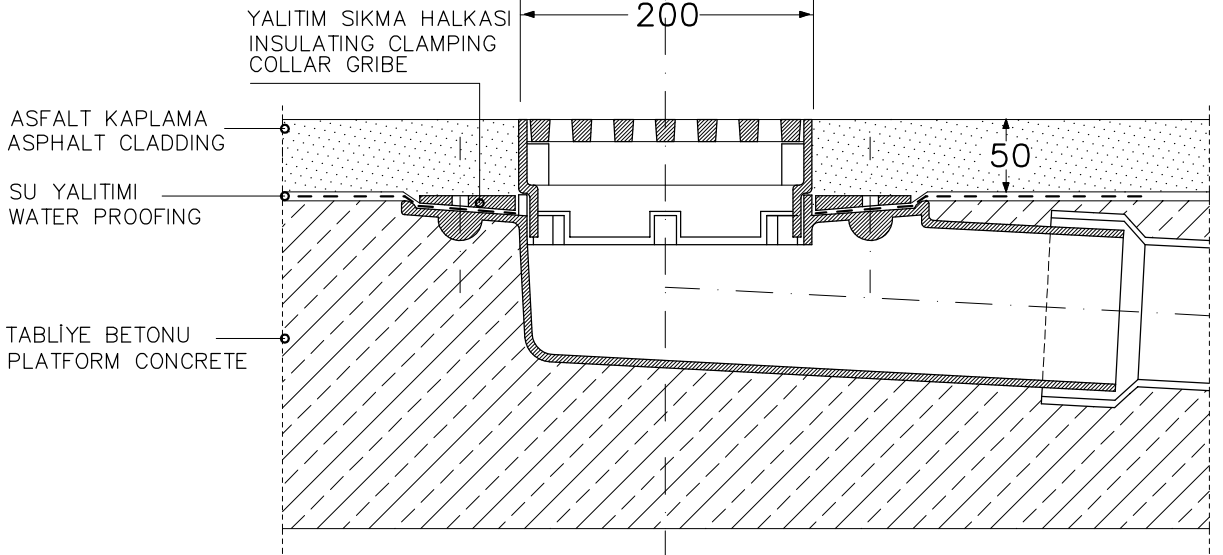

KESİT/SECTION

KOD NO: CODE NO:	ÇAP DIAMETER	AĞIRLIK WEIGHT kg.	KESİT KALINLIĞI WALL THICKNESS mm.	SERVİS ALANI SERVICE AREA m ²	MALZEME/ MATERIALS	
					ALT GÖVDE BOTTOM PART	ÜST İZGARA UPPER GRATING
S807-100	ø100	20	5	150	PİK DÖKÜM CASTING	PİK DÖKÜM CASTING